

AKM[®] 2G Low Voltage Servo Motor Selection Guide

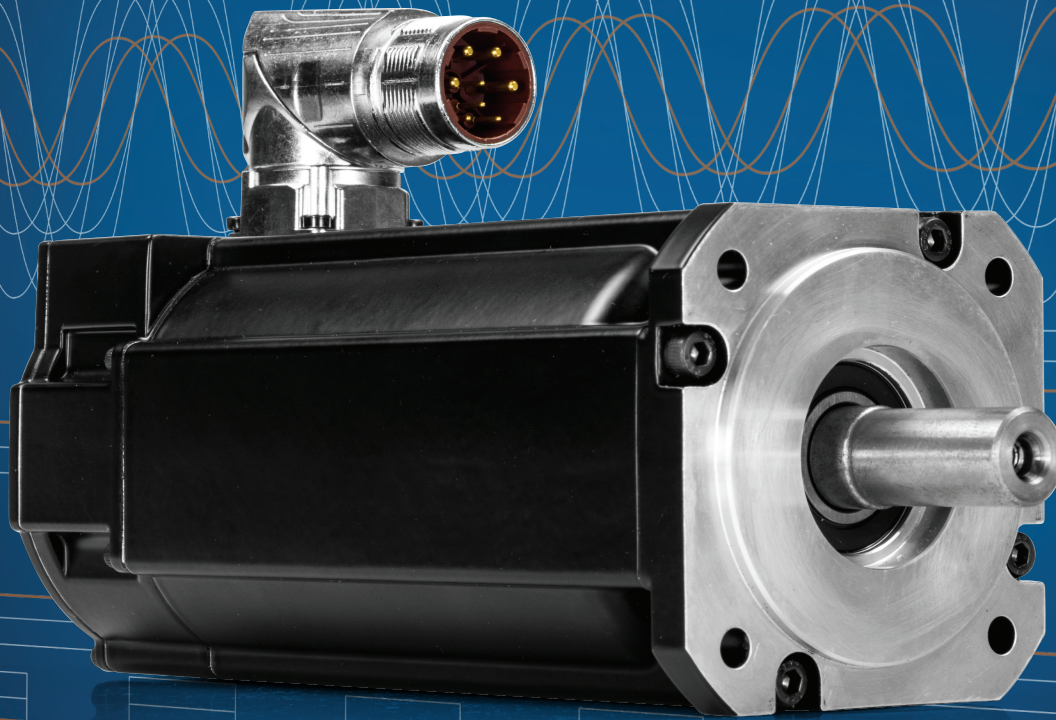

KOLLMORGEN[®]

Because Motion Matters™

Kollmorgen: Your partner. In Motion.

Every solution comes from a real understanding of the challenges facing machine designers and users.

Innovators consistently rate Kollmorgen as one of their best motion systems manufacturing partners. Whether you are looking for classic servo motors, direct-drive servo motors, stepper motors, drives & amplifiers, gearing, actuation, or multi-axis motion controllers, Kollmorgen is one of the few companies in the world who actually designs and manufactures all of these products.

Our customers are leaders in many industries such as Aerospace & Defense, Printing, Packaging & Converting, Food & Beverage Processing, Medical Imaging, In Vitro Diagnostics & Laboratory Automation, Pharmaceutical Manufacturing, Material Forming and Cutting, Oil & Gas, and Robotics. Kollmorgen is also a leader in Warehouse Automation, including complete AGV systems, software, awareness and autonomy.

Our Automation Solutions can be found on Mars and in space, ships and submarines, O&G drilling and metrology, surgical robots and laser eye surgery, even inside artificial hearts. These are just a few applications that demand high-performance and high-quality while satisfying their specific needs.

Because motion matters, it's our focus: Motion can distinctly differentiate a machine and deliver a marketplace advantage by increasing its performance and dramatically improving overall equipment effectiveness (OEE).

High-performance motion can make your customer's machine more reliable and energy-efficient, enhance accuracy and improve operator safety. Motion also represents endless possibilities for innovation.

We've always understood this potential, and thus have kept motion at our core and in our Vision, Mission & Values, relentlessly developing products that offer precise control of torque, velocity and position accuracy in machines that rely on complex motion.

Removing the Barriers of Design, Sourcing, and Time

At Kollmorgen, we know that OEM engineers can achieve a lot more when obstacles aren't in the way. So, we clear obstacles in three important ways:

Integrating Standard and Custom Products

The optimal solution is often not clear-cut. Our application expertise allows us to modify standard products or develop totally custom solutions across our whole product portfolio so that designs can take flight.

Providing Motion Solutions, Not Just Components

As companies reduce their supplier base and have less engineering manpower, they need a total system supplier with a wide range of integrated solutions. Kollmorgen offers complete solutions as well as motion subsystems that combine programming software, engineering services and best-in-class motion components.

Global Footprint

With direct sales, engineering support, manufacturing facilities, and distributors spanning the Americas, Europe, the Middle East, and Asia, we're close to OEMs worldwide. Our proximity helps speed delivery and lend support where and when they're needed.

Financial and Operational Stability

Kollmorgen is part of Altra Industrial Motion. A key driver in the growth of all Altra divisions is the Altra Business System, which relies on the principle of "kaizen" – or continuous improvement. Using world-class tools, cross-disciplinary teams of exceptional people evaluate processes and develop plans that result in superior performance.

Kollmorgen: Your partner. In Motion.**Trademarks**

AKD is a registered trademark of Kollmorgen Corporation
 AKM is a registered trademark of Kollmorgen Corporation
 EnDat is a registered trademark of Dr. Johannes Heidenhain GmbH
 EtherCAT is a registered trademark and patented technology, licensed by Beckhoff Automation GmbH
 Ethernet/IP is a registered trademark of ODVA, Inc.
 Ethernet/IP Communication Stack: copyright (c) 2009, Rockwell Automation
 sercos[®] is a registered trademark of sercos[®] international e.V.
 HIPERFACE and HIPERFACE DSL are registered trademarks of Max Stegmann GmbH
 PROFIBUS is a registered trademark of PROFIBUS and PROFIBUS International (PI)
 SIMATIC is a registered trademark of SIEMENS AG
 SpeedTec, ytec, itec and hitc are registered trademarks of TE Connectivity Ltd.
 Windows is a registered trademark of Microsoft Corporation

Table of Contents

▶ AKM [®] Servo Motor Family	4
▶ AKM [®] 2G Servo Motor Family Options	6
▶ AKM [®] 2G Systems Overview	7
▶ AKM [®] 2G3 Performance Data and Drawings	8
Performance Data	8
Performance Curves	10
Derate Curves	14
Dimensional Drawings	15
▶ L10 Bearing Fatigue and Shaft Loading	16
▶ Thermal Sensor Protective Devices	17
▶ Brake Option	18
▶ Feedback Options	19
▶ Servo Motor Feedback Combinations	20
▶ AKM2G Servo Motor Connector Pinouts	22
▶ AKM2G Servo Motor Nomenclature	24
▶ Kollmorgen Solutions	25
Automation and Motion Control	25
Self-help Tools	25

AKM® Servo Motor Family

Kollmorgen's AKM family of servo motors gives you unprecedented choice and flexibility from a wide range of standard products so you can select the best servo motor for your application.

From the Low Voltage motors in this Selection Guide to the broad range of AKM and AKM2G motors that support voltages up to 480 Vac, washdown, food grade, and the AKMH stainless steel hygienic motor for the toughest environments- Kollmorgen has a standard motor solution that can meet your needs right from the catalog.

Still need more? For your truly unique motion control applications, work with our engineering team to customize a solution for your machine design. Either way, standard product or customized, we can help you choose the motion control solution that meets your exact requirements.

The Benefits of AKM2G Low Voltage Servo Motors

Smaller footprint reduces machine space

- For equivalent power it is possible to use a smaller size motor than competitive motors.
 - Use of the smaller motor saves space achieving equivalent performance in a smaller footprint machine or saving space for other machine elements.
-

Voltage options to match application needs

- Standard voltage selections of 24, 48, 72 and 96 Vdc meet most available power sources
 - Kollmorgen can work with you to meet your specific requirements for the exact solution you need.
-

Wider speed range provides faster operation

- For many AKM2G sizes the maximum speeds are higher than competitive motors.
 - Higher speeds ⇒ operate machines faster ⇒ greater throughput.
-

Greater flexibility provides more options to match needs

- AKM2G is designed to support a wider array of feedback, brake, thermal sensor and shaft seal options – this greater flexibility means a higher probability of meeting application requirements with a standard product.
 - The AKM2G design has the potential for greater CoEngineering (modification) thanks to the new housing design. With a more flexible design for CoEngineering addressing applications not covered by catalog standards is increased.
-

Higher efficiency reduces energy consumption

- AKM2G has lower equivalent resistance than competitive solutions. For equivalent motor frame sizes AKM2G will typically be more energy efficient (2-5%).
- Energy consumption is reduced with AKM2G compared to competitors.
- When weight and space are critical such as on portable, mobile or battery power applications higher efficiency translates to a smaller motor with lower energy demand.

AKM[®]2G Servo Motor Family Options

AKM[®]2G Servo Motors

Higher Power Density

Performance – Efficiency

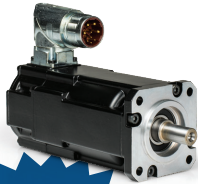

Standard low voltage models coming soon.

AKM2G-2x

Flange: 58 mm
Power: 0.206 - 1.16 kW
Max Speed: 8000 RPM
Stacks: 4

The smallest AKM2G. For dual cable connection with resolvers the compact ytec[®] connector is used for motors above 120 Vac.



Now available in standard low voltage models.

AKM2G-3x

Flange: 72 mm
Power: 0.175 - 1.77 kW
Max Speed: 8000 RPM
Stacks: 3

Available with motor-mounted rotatable single or dual cable connectors (feedback dependent).



Standard low voltage models coming soon.

AKM2G-4x

Flange: 88 mm
Power: 0.267 - 2.85 kW
Max Speed: 6000 RPM
Stacks: 4

Available with motor-mounted rotatable single or dual cable connectors (feedback dependent).

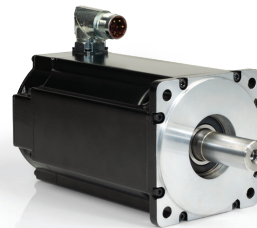

AKM2G-5x

Flange: 114 mm
Power: 0.78 - 5.28 kW
Max Speed: 6000 RPM
Stacks: 4

Available with motor-mounted rotatable single or dual cable connectors (feedback dependent).

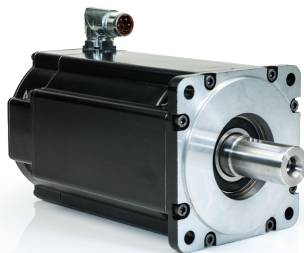

AKM2G-6x

Flange: 142 mm
Power: 1.56 - 7.79 kW
Max Speed: 6000 RPM
Stacks: 4

Available with motor-mounted rotatable single or dual cable connectors (feedback dependent).

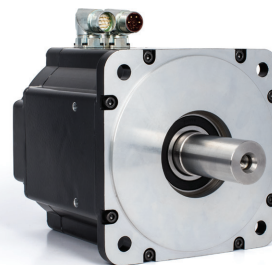

AKM2G-7x

Flange: 192 mm
Power: 2.42 - 11.8 kW
Max Speed: 6000 RPM
Stacks: 4

Provides torque levels previously seen only in larger size motors. Offered with motor-mounted rotatable single or dual cable connectors (feedback dependent), including optional holding brakes.

Kollmorgen Cables Offer the Complete Solution



Kollmorgen offers complete cable solutions for connecting drives and motors. This includes static, low cost cable sets for simple applications to high bend, high flex, hybrid cables that combine feedback and power in one cable. Not sure which cable offering would best suit your needs? No problem. See the Kollmorgen 2G Cable Guide, or Kollmorgen Customer Support is available to discuss cable options and what makes the most sense for your machine.

AKM[®] 2G Systems Overview

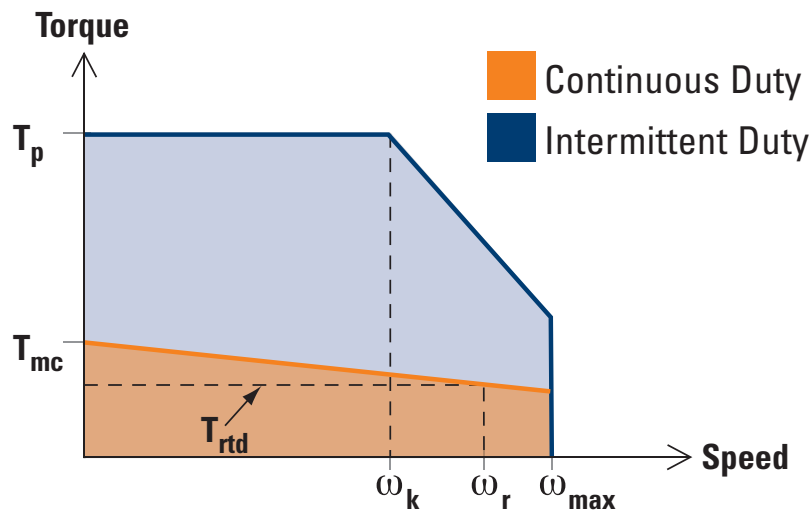

Definitions	
T_p	- Peak torque
T_{mc}	- Maximum continuous torque
T_{rtd}	- Continuous rated torque (torque at rated power)
ω_{max}	- Maximum speed
ω_r	- Rated speed (speed at rated power)
ω_k	- Speed at knee in peak envelope (intersection of system peak torque with voltage limit line)

Curves shown on the following pages are for resolver/non-brake/non-seal motors only. For other motor curves please refer to Kollmorgen's Motioneering Application Sizing programs, the Kollmorgen website Performance Curve Generator or contact Kollmorgen customer support for assistance.

How to Build a Servo Drive and Motor System

Performance data on the following pages is designed to help you select the optimum brushless servo motor.

Drive and Motor Performance Curves

The performance characteristics of a brushless servo system (motor/drives combination) are described by a torque/speed operating envelope. As shown above, the shaded areas of the curve indicate the continuous duty and intermittent duty zones of the system.

Continuous Duty Zone

The continuous duty zone is bordered by the maximum continuous torque line up to the intersection with the intermittent duty line. The continuous torque line is set by either the motor's maximum rated temperature, or the drives' rated continuous current output, whichever is less. The system voltage limit line is set by the voltage rating of the drives, the line voltage supplied, and the motor winding. The system can operate on a continuous basis anywhere within this area, assuming the ambient temperature is 40°C or less.

Intermittent Duty Zone

The intermittent duty zone is bordered by the peak torque line and the system voltage limit line. The peak torque line is set by either the drives' peak current rating, which the drive can produce for a limited time, or the maximum rated peak current for the motor, whichever is less. Refer to the Rating Data on the following pages. Note: Higher torque levels may be achievable at higher power levels.

Consult Kollmorgen Customer Support for more details. The system voltage limit line is set by the voltage rating of the drive, the line voltage applied and the motor winding. Operation in the intermittent zone must be limited to a duty cycle that will produce an RMS system torque falling within the continuous duty area. The RMS torque value is a function of the magnitude of the intermittent torque and the percentage of the time spent at that torque.

De-rate Calculations

De-rate curves shown for each motor variation (refer to page 14) assume continuous operation at the selected speed and at maximum rated temperature. Operating intermittently and/or at less than rated temperatures will reduce the De-rate. Kollmorgen Customer Support is available to discuss the specifics of your application and optimum sizing.

AKM2G-3x Performance Data

AKM2G-3x Low Voltage Servo Motor Performance Data – Up to 96 Vdc voltage

Parameters	Tol	Symbol	Units	AKM2G-31		AKM2G-32		AKM2G-33	
				ML	PL	ML	PL	ML	PL
Max Rated Equivalent Line Voltage	Max	Vbus	Vac	170	170	170	170	170	170
Max Continuous Torque for ΔT winding = 100°C ①②③⑤	Nom	T_{cs}	Nm	1.73	1.69	2.89	2.77	3.82	3.83
			lb-in	15.3	15.0	25.6	24.6	33.8	33.9
Continuous Current for ΔT winding = 100°C ①②③	Nom	I_{cs}	A_{rms}	14.2	20.0	14.8	20.0	14.8	20.0
Max Continuous Torque for ΔT winding = 60°C ②③⑤	Nom	T_{cs}	Nm	1.34	1.33	2.25	2.23	2.97	3.01
			lb-in	11.9	11.8	19.9	19.7	26.3	26.7
Max Mechanical Speed ④	Nom	N_{max}	rpm	8000	8000	8000	8000	8000	8000
Peak Torque ①②③	Nom	T_p	Nm	6.14	6.09	10.7	10.6	14.5	14.6
			lb-in	54.3	53.9	94.6	93.7	128	130
Peak Current	Nom	I_p	A_{rms}	56.8	80.7	59.1	82.4	59.0	80.8
Rated Torque (speed) ①②③		T_{rtd}	Nm	-	1.67	-	2.79	-	3.82
			lb-in	-	14.8	-	24.7	-	33.8
Rated Speed		N_{rtd}	rpm	-	2200	-	1300	-	800
Rated Power (speed) ①②③		P_{rtd}	kW	-	0.385	-	0.379	-	0.320
			Hp	-	0.517	-	0.509	-	0.430
Rated Torque (speed) ①②③		T_{rtd}	Nm	1.65	1.57	2.81	2.70	3.69	3.64
			lb-in	14.6	13.9	24.9	23.9	32.6	32.2
Rated Speed		N_{rtd}	rpm	3300	4900	2000	3000	1500	2100
Rated Power (speed) ①②③		P_{rtd}	kW	0.570	0.804	0.589	0.849	0.579	0.801
			Hp	0.764	1.08	0.790	1.138	0.777	1.07
Rated Torque (speed) ①②③		T_{rtd}	Nm	1.57	1.41	2.70	2.51	3.54	3.38
			lb-in	13.9	12.4	23.9	22.2	31.3	30.0
Rated Speed		N_{rtd}	rpm	5200	7800	3200	4700	2400	3400
Rated Power (speed) ①②③		P_{rtd}	kW	0.853	1.15	0.906	1.23	0.890	1.21
			Hp	1.14	1.54	1.215	1.66	1.19	1.62
Rated Torque (speed) ①②③		T_{rtd}	Nm	1.46	-	2.57	2.26	3.34	3.06
			lb-in	12.9	-	22.7	20.0	29.6	27.1
Rated Speed		N_{rtd}	rpm	7200	-	4400	6400	3400	4700
Rated Power (speed) ①②③		P_{rtd}	kW	1.10	-	1.18	1.51	1.19	1.50
			Hp	1.47	-	1.59	2.03	1.60	2.02

Notes:

- ① Motor winding temperature rise, $\Delta T = 100^\circ C$, at $40^\circ C$ ambient.
- ② All data referenced to sinusoidal commutation.
- ③ Motor with resolver feedback and standard heat sink.
- ④ May be limited at some values of Vbus.
- ⑤ See de-rate curves for the de-rate of different motor options

AKM2G – 3 2 ML AN C N 2- 10*
 Motor Series Frame Size Rotor Length Winding Shaft Flange Connector Brake Feedback Customization Thermal Sensor

AKM2G-3X PERFORMANCE DATA

AKM2G-3x Low Voltage Servo Motor Performance Data – Up to 96 Vdc voltage (Continued)

Parameters	Tol	Symbol	Units	AKM2G-31		AKM2G-32		AKM2G-33	
				ML	PL	ML	PL	ML	PL
Torque Constant ①	±10%	K _t	Nm/A _{rms}	0.124	0.087	0.201	0.142	0.265	0.196
			lb-in/A _{rms}	1.10	0.766	1.78	1.261	2.34	1.731
Back EMF Constant ②	±10%	K _e	V _{rms} /k _r rpm	8.09	5.64	13.09	9.28	17.2	12.7
Motor Constant ⑥	Nom	K _m	N-m/√W	0.211	0.210	0.335	0.332	0.422	0.428
			lb-in/√W	1.87	1.85	2.97	2.94	3.74	3.79
Resistance (line-line) ②	±10%	R _m	Ohm	0.230	0.114	0.240	0.122	0.262	0.139
Inductance Q-Axis (line-line)		L _{qll}	mH	0.54	0.26	0.57	0.29	0.61	0.33
Inductance D-Axis (line-line)		L _{dll}	mH	TBD	TBD	TBD	TBD	TBD	TBD
Inductance Saturation Current		L _{isat}	Arms	188	270	236	333	270	366
Maximum Demagnetization Current		Midpeak	Arms	TBD	TBD	TBD	TBD	TBD	TBD
Inertia (includes Resolver feedback) ③	±10%	J _m	kg-cm ²	0.426		0.813		1.200	
			lb-in-s ²	3.77E-04		7.20E-04		1.06E-03	
Optional Brake Inertia (additional)	±10%	J _m	kg-cm ²	0.120		0.120		0.120	
			lb-in-s ²	1.06E-04		1.06E-04		1.06E-04	
Weight without brake ④		W	kg	1.8		2.5		3.3	
			lb	4.0		5.6		7.2	
Static Friction ①⑤		T _f	Nm	0.013		0.023		0.031	
			lb-in	0.12		0.20		0.27	
Viscous Damping ①		K _{dv}	Nm/k _r rpm	0.0039		0.0078		0.0117	
			lb-in/k _r rpm	0.035		0.069		0.104	
Thermal Time Constant		TCT	minutes	17		21		25	
Coil Thermal Time Constant		MCT _{f0}		TBD		TBD		TBD	
Thermal Resistance ①		R _{thw-a}	K/W	0.980		0.868		0.795	
Pole Pairs		PP		4		4		4	
Heat Sink Size				10"x10"x1/4" Aluminum Plate		10"x10"x1/4" Aluminum Plate		10"x10"x1/4" Aluminum Plate	

Notes:

- ① Motor winding temperature rise, ΔT = 100° C, at 40° C ambient.
- ② Measured at 25° C.
- ③ Add parking brake if applicable for total inertia.
- ④ Brake motor adds 0.72 kg [1.6 lbs]
- ⑤ Shaft seal increases Static Friction by 0.017 Nm [0.15 lb-in]
- ⑥ This value is calculated from the Torque Constant and Resistance. Refer to those values and notes ① & ② for additional details.

*Complete AKM2G-3 low voltage servo motor series model nomenclature can be found on page 24.

AKM2G-3x Performance Curves

AKM2G-31xx Torque-Speed Performance Curves

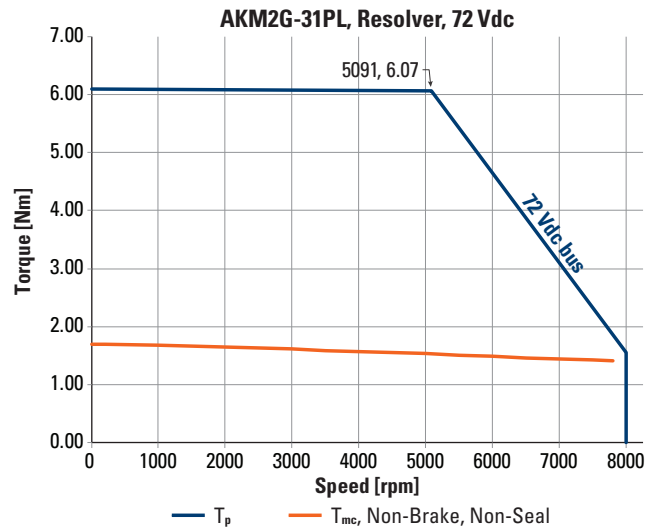
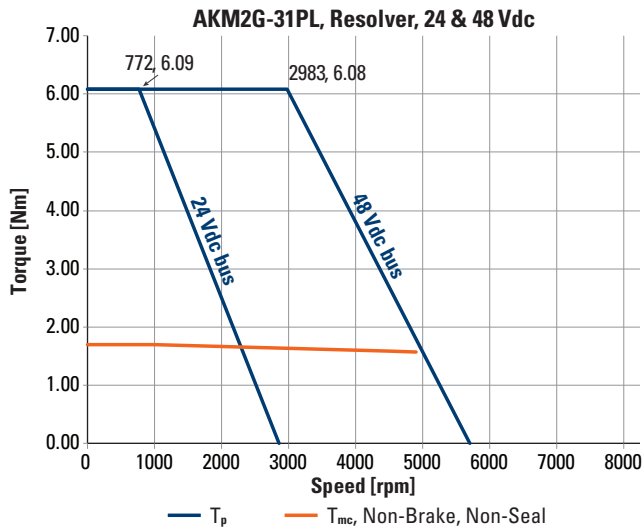
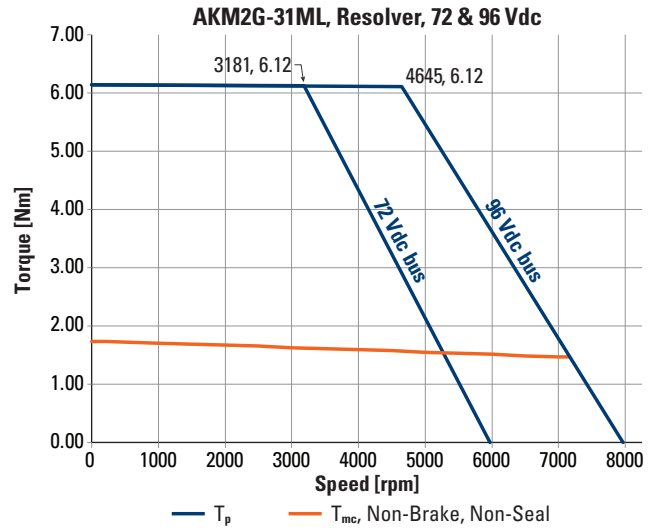
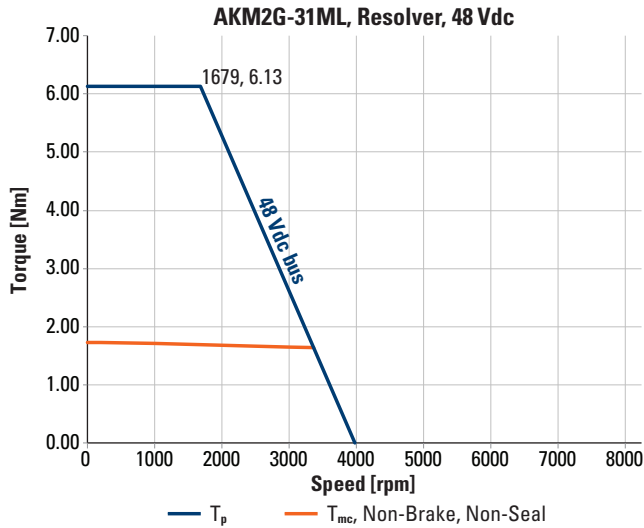

T_p = Peak torque
 T_{mc} = Maximum continuous torque
 Refer to page 7 for torque-speed curve properties.

AKM2G-32xx Torque-Speed Performance Curves

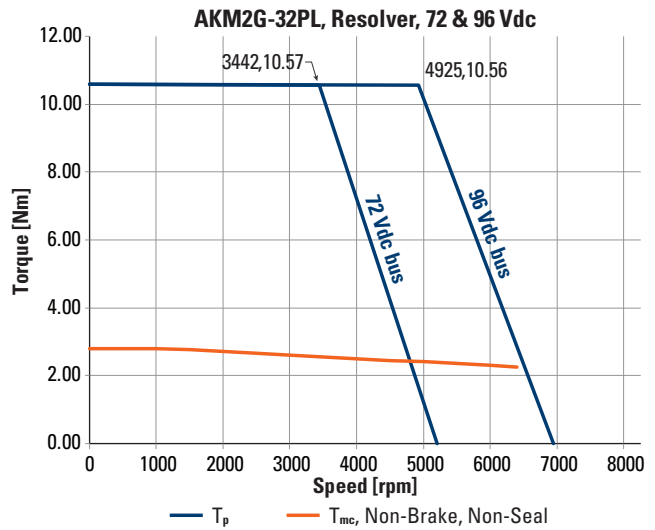
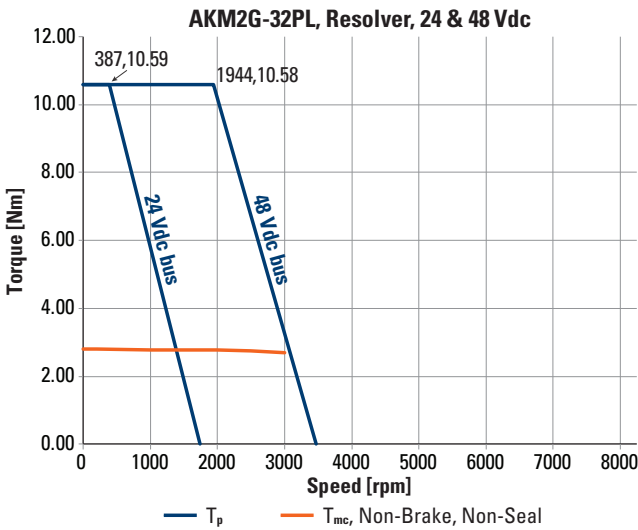
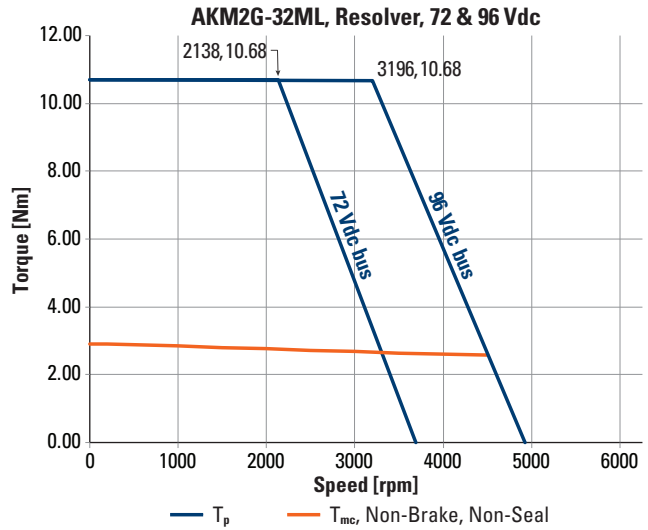
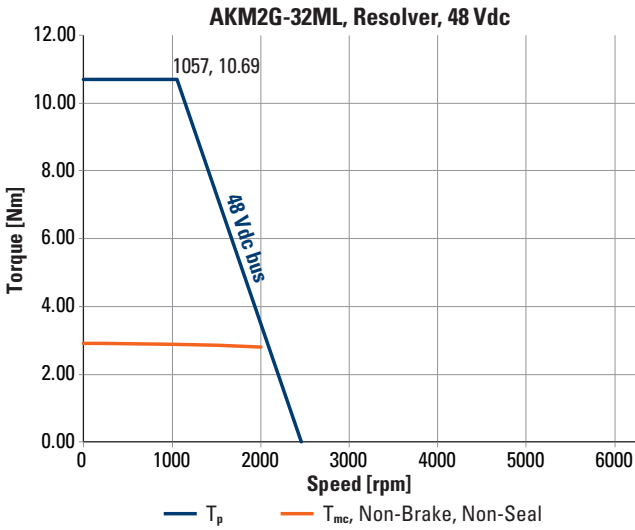

T_p = Peak torque
 T_{mc} = Maximum continuous torque
 Refer to page 7 for torque-speed curve properties.

*Complete AKM2G-3 low voltage servo motor series model nomenclature can be found on page 24.

AKM2G-3x Performance Curves

AKM2G-33xx Torque-Speed Performance Curves

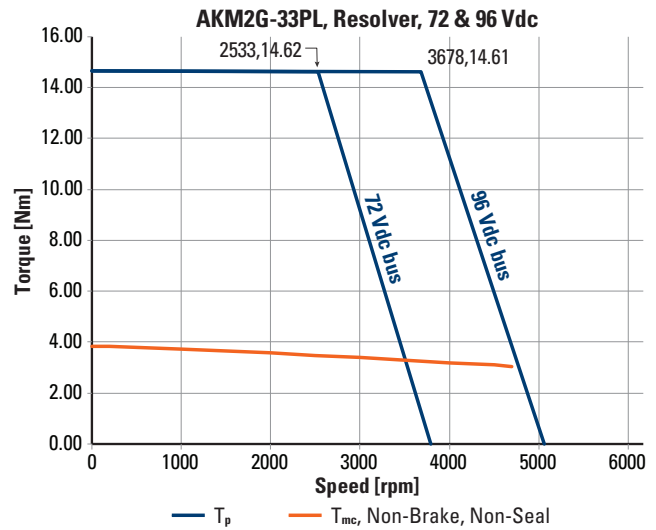
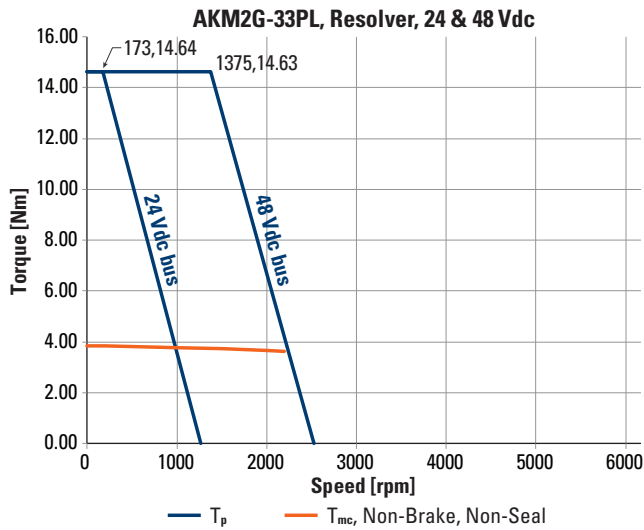
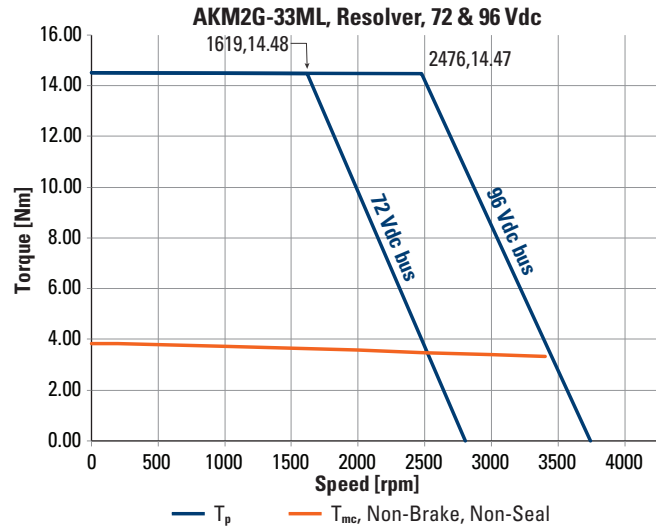
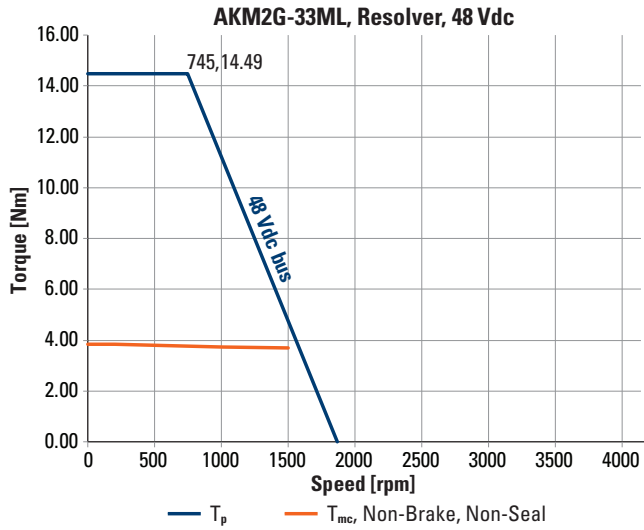

T_p = Peak torque
 T_{mc} = Maximum continuous torque
 Refer to page 7 for torque-speed curve properties.

Notes



AKM2G-3x Low Voltage De-rate Curves*

The De-rate curves below are specific to the AKM2G Low Voltages motors. For AKM2G motors used with source voltages of 120 Vac or greater please refer to the AKM2G Selection Guide.

De-rate is calculated by multiplying the torque value (T_{mc}) by the percentage De-rate for the appropriate feedback either with or without shaft seal at the desired speed point. Also, use the correct De-rate graph for the motor based on whether it will have a brake or no brake. Refer to De-rate Calculations in the AKM2G Systems Overview on page 7 for additional details about De-rate calculations.

Example:

For an AKM2G-31 motor with a DSL feedback no shaft seal and no brake operating at 2000 RPM there is a 4.5% De-rate. Multiply the motor torque value (T_{mc}) by .955 for the rated torque at 2000 RPM. For ease of interpretation of the graph using a De-rate that is a rounded approximation is acceptable. For exact values refer to Kollmorgen's Motioneering Application Sizing programs, or the Kollmorgen website Performance Curve Generator.

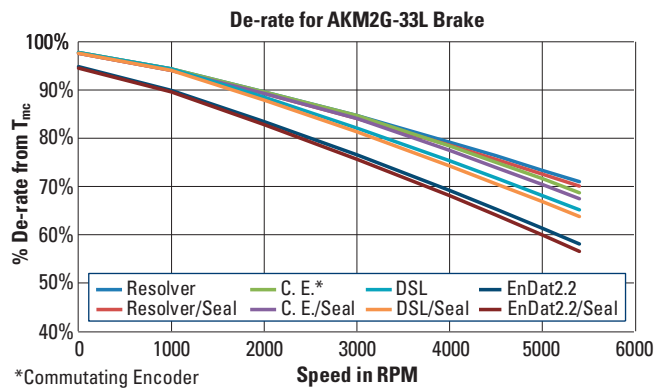
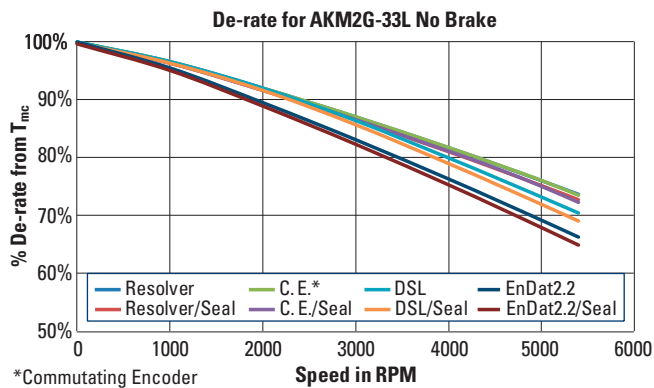
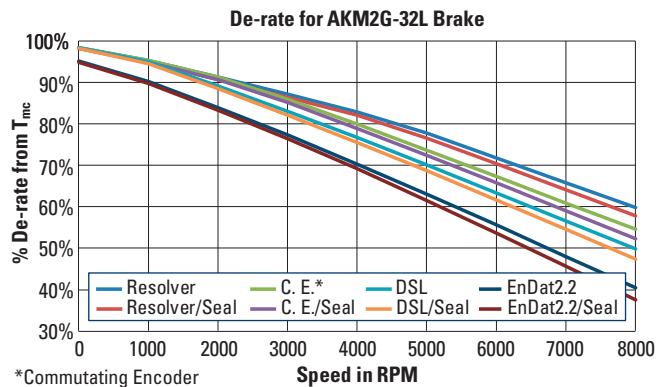
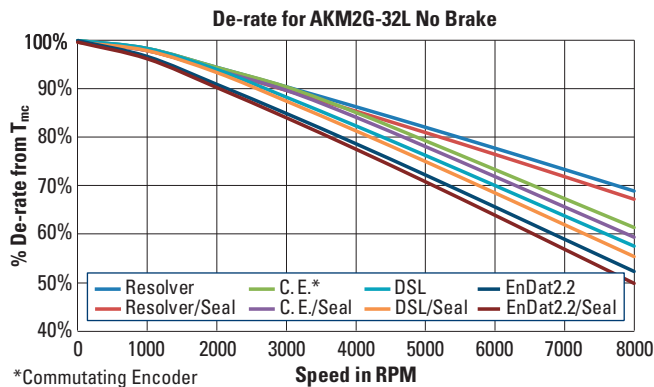
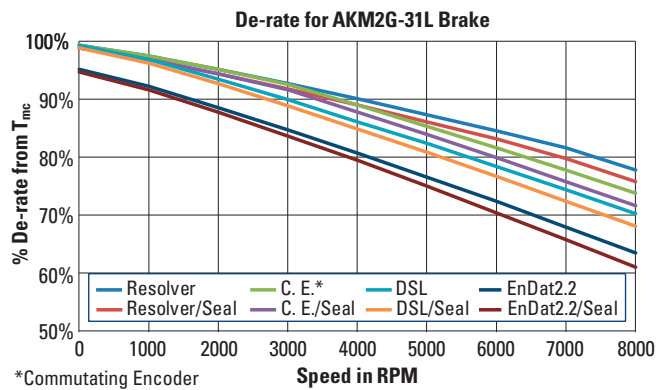
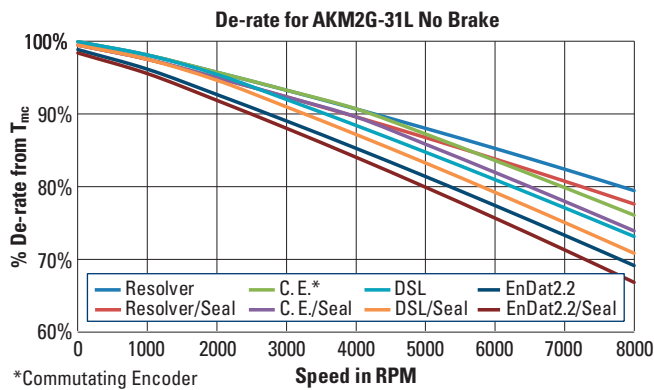

* De-rate information for general estimation only. Use the on-line Performance Curve Generator located at <http://pcgh.kollmorgen.com/> for the most accurate information for your motor, or refer to Kollmorgen's Motioneering Software Tool available for download at <https://www.kollmorgen.com/en-us/service-and-support/technical/motioneering/motioneering/>

AKM2G-3x Drawings

AKM2G – 3 2 ML AN C N 2- 10*

Motor Series
Frame Size
Rotor Length
Winding
Shaft
Flange
Connector
Brake
Feedback
Thermal Sensor
Customization*

AKM2G-3x Single Connector Frame

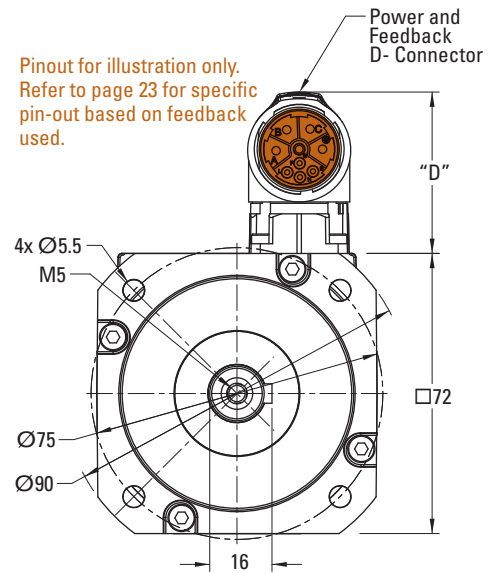
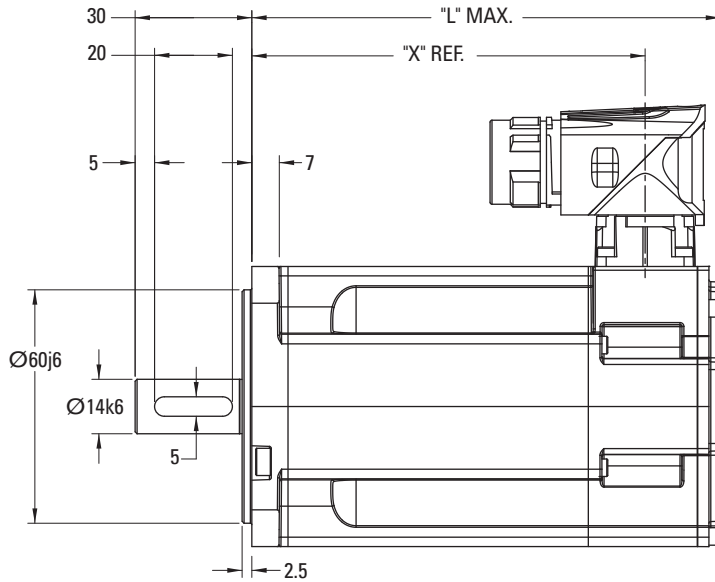

D- Connector Feedback	"D"
DSL & EnDat	42.8

AKM2G-3x "X" and "L" Dimensions

Model	No Brake		
	X	Resolver / Commutating Encoder L	DSL / EnDat 2.2 L
AKM2G-31L	101.1	121.4	129.4
AKM2G-32L	132.25	152.55	160.55
AKM2G-33L	163.4	183.7	191.7

Model	Brake		
	X	Resolver / Commutating Encoder L	DSL / EnDat 2.2 L
AKM2G-31L	142.3	162.6	170.6
AKM2G-32L	173.45	193.75	201.75
AKM2G-33L	204.6	224.9	232.9

AKM2G-3x Dual Connector Option

Pinouts for illustration only. Refer to page 22 for specific pin-out based on feedback used.

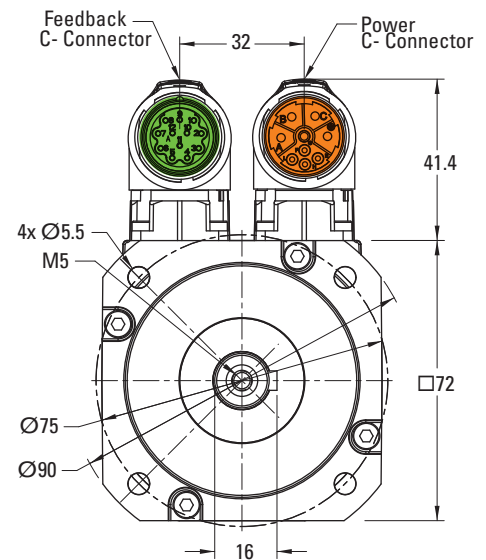

*Complete AKM2G-3 low voltage servo motor series model nomenclature can be found on page 24.

L10 Bearing Fatigue and Shaft Loading

Bearing Life

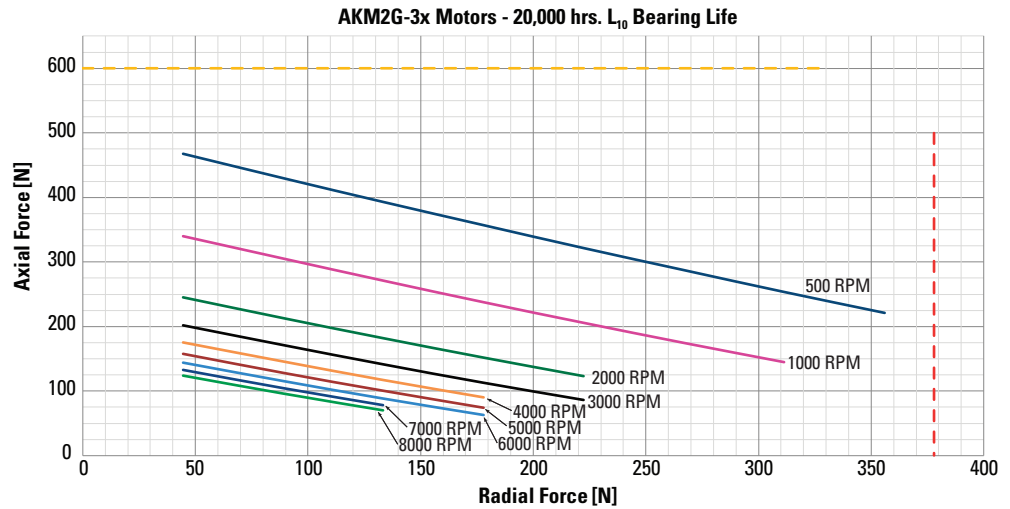

Shaft Loading

Motor	Max. Radial Force (N)	Max. Axial Force (N)
AKM2G-3	340	600

The maximum radial load ratings reflect the following assumptions:

1. Motors are operated with peak torque of the longest member of the frame size.
2. Fully reversed load applied to the end of the smallest diameter standard mounting shaft extension.
3. Infinite life with 99% reliability.
4. Safety factor = 2.

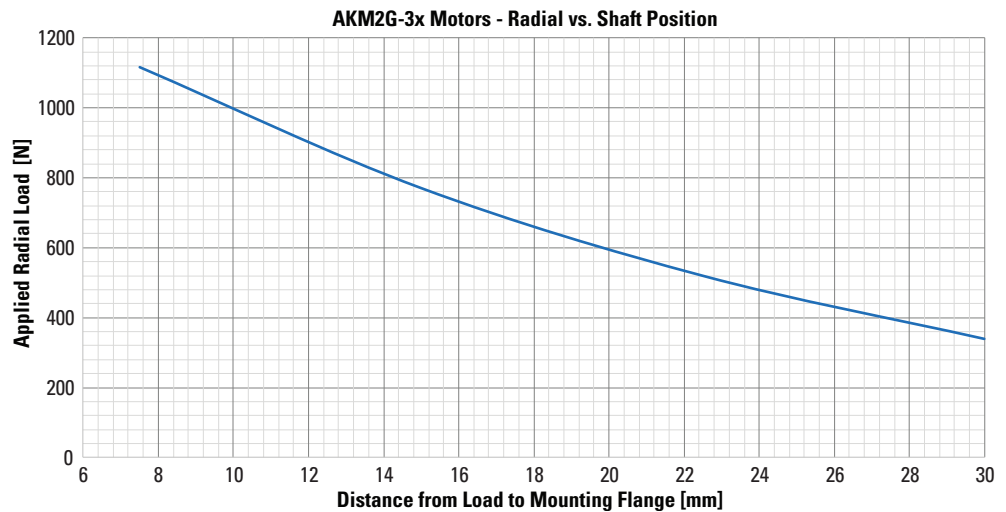

Mineral-filled PTFE Teflon® Shaft Seals

There is a normal break-in period for our Mineral-filled PTFE Teflon® shaft seals. Best conditions during the break-in period would be at the operational temperature and speed that would be typical for the application.

During the break-in period, some “shedding” of mineral-filled PTFE Teflon material is normal. The debris is not a sign of seal deterioration or failure. The material “shed” should be reduced with usage.

Typically, a few hours at operational speed is enough to break-in the shaft seal.

Thermal Sensor Protective Devices

The standard version of each motor is fitted with an electrically isolated PT-1000. The thermal sensors do not provide any protection against short, heavy overloading.

The motor can be delivered with a PT-1000 + PTC, PTC, or KTY 84-130 equivalent sensors optionally (see Thermal Sensor options 2, 3, 0).

With digital feedback systems Hiperface DSL (GU) and EnDat 2.2 (LD) the temperature sensor status is transmitted digitally and evaluated in the drive.

Provided that our configured feedback cables are used, the sensor is integrated into the monitoring system of the digital servo amplifiers.

Thermal Device Options: Resistance vs. Temperature Graphs

Kollmorgen AKD & AKD2G drives can directly interpret information from the motor thermal sensors to properly reflect the motor winding temperature. For other drives please refer to the graph Delta Between Motor Winding and Thermal Device on the following page.

Standard 1

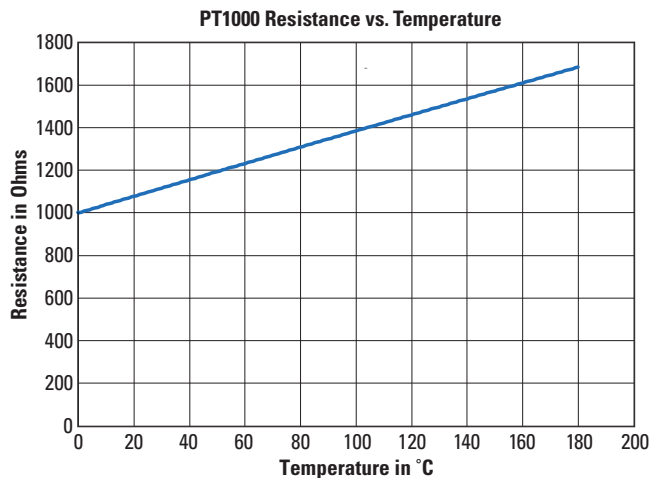

Option 2

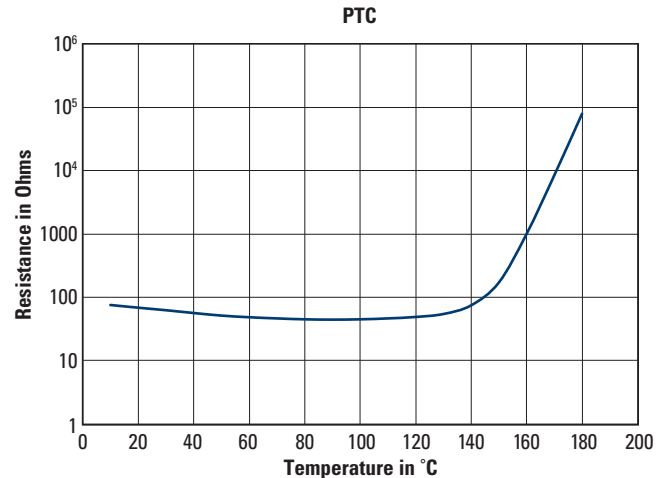

Option 3

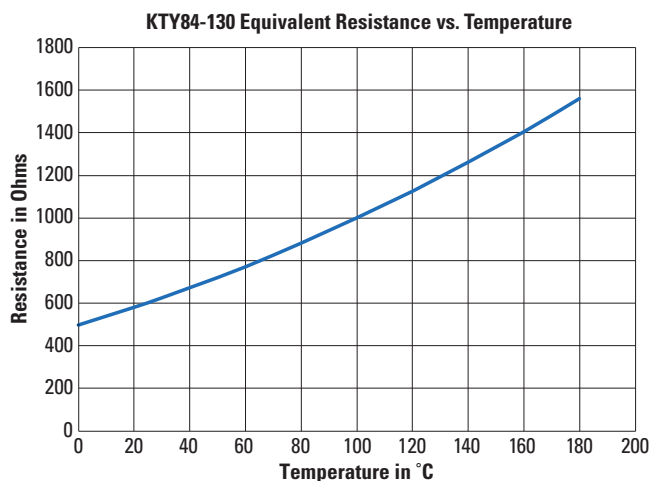

Option 0

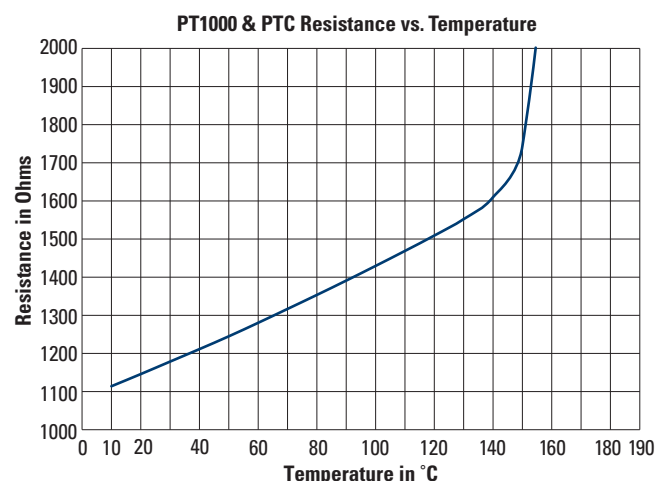

Thermal Sensor Protective Devices

Delta Between Motor Winding and Thermal Device

When using a drive other than the Kollmorgen AKD or AKD2G you will need to account for the difference (Delta) in temperature between the value reported by the thermal sensor and the actual motor winding temperature. This is necessary to insure proper operation and protection of the motor.

The provided graph shows the delta between the reported device temperature on the x axis and the motor winding temperature on the y axis and should be used to adjust the response of the system for the difference between the thermal sensors reported temperature and the actual motor winding temperature.

Examples:

At 60°C on thermal device temperature the winding temperature will be 1.8°C higher (61.8°C).

At 130°C on thermal device temperature the winding temperature will be 8.1°C higher (138.1°C).

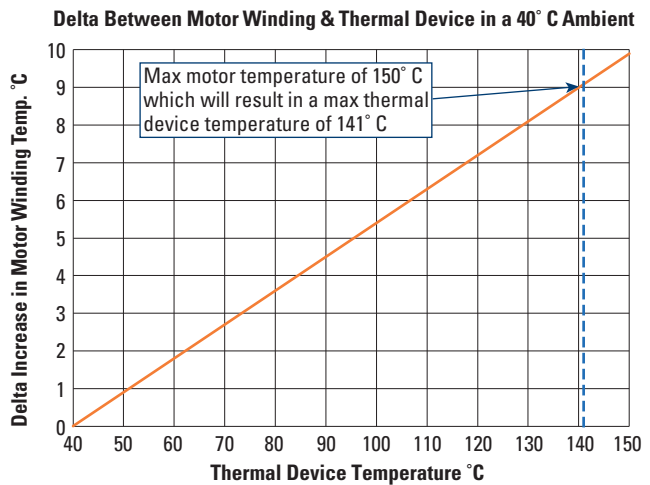

Brake Option

Failsafe, Holding Brake

The holding brake is designed to provide static holding torque to the motor shaft with the brake coil de-energized. The brake must first be released (coil energized) prior to commanding motor rotation as determined by its drop-out time. The brake is intended for holding or “parking” of a stationary motor. It is not intended for dynamic braking. There should be absolutely no motion of the rotor when power is removed from the brake coil.

AKM2G-3 Motor Brake Specifications

Motor Family	Minimum Static Torque @120°C		Weight Adder		Power Consumption Nominal Watts ±7%	Current ¹ @24 V, 20°C ADC	Inertia Adder		Closing Time (engage) msec	Opening Time (release) msec	Backlash ²	
	Nm	lb-in	Kg	lb			kg-cm ²	lb-in-sec ²			Maximum deg.	Typical deg.
AKM2G-3	3.3	29.205	0.72	1.6	12.6	0.53	0.12	1.1E-04	17	55	1	0.6

Contamination of the motor internal compartment by oil or other foreign materials will result in failure of the brake. Check the suitability of motor sealing for the working environment.

Note 1: Operating Voltage: 24 Vdc ± 10%.

Note 2: Maximum backlash is calculated using worst-case tolerancing, and typical backlash is calculated using statistical tolerancing.

Feedback Options

Phasing Diagram - All Motors

Motor Winding Configuration

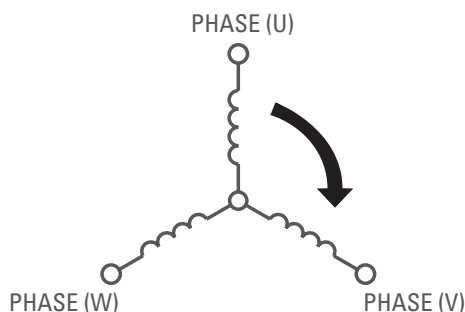

General note:

When motor is rotated CW (viewed from drive shaft end), these waveforms result:
Voltage U, leads V, leads W.
Voltage U-W leads Voltage V-W by 60° electrical.

AKM2G-3 LV Servo Motor Feedback Summary with AKD Family Servo Drives

Code	Description	Connector	Type	Size	Motor ID Support ³	Accuracy ^{1,2} (arc-sec)	RMS Noise ¹ (arc-sec)	Resolution	Absolute revs.	Compatible Drives
2-	Commutating Encoder	C/G	Optical	15	No	±218.2"	N/A	12 bits	None	AKD/AKD2G
GU	HIPERFACE DSL®	D	Capacitive	EEM37	Yes	±240"	±20"	17 bits	4096	AKD/AKD2G
LD	EnDat® 2.2	D	Inductive	EQI 1131	Yes	±120"	See Note 4	19 bits	4096	AKD/AKD2G
R-	Resolver	C/G	Inductive	15	No	±540"	N/A	24 bits for AKD/AKD2G	1	All

Note 1: AKD/AKD2G drives have a resolver measurement accuracy of ±45", for a drive w/ motor accuracy of ±585" and RMS Noise of ±9.9". Accuracy & RMS Noise data when used with other drives may be different.

Note 2: Accuracy refers to overall system accuracy once installed in the motor. Noise refers to the RMS position noise when at stand-still.

Note 3: Motor ID support means electronic motor nameplate data is included, allowing for plug-and-play commissioning.

Note 4: At the time of printing, this information was not available. Please contact Kollmorgen Customer Support for the latest update.

With AKD and AKD2G drives, all received positions are interpolated to a 32-bit resolution per revolution. When using a drive other than AKD or AKD2G consult the drive manufacturer for this information.

Connector Options for AKM2G-3 Low Voltage Servo Motors

Model Designation	Connection	Position of connection
C	2 SpeedTec® M23	Angular, rotatable, motor mounted
D*	1 htec® M23	Angular, rotatable, motor mounted
G	2 SpeedTec® M23	Straight, motor mounted

* Hybrid connectors valid for DSL and EnDat Feedback only.

Connector Description

Connector	Usage	Contacts - Pins Power/Signal	Max. Current [A] Power/Signal	Max. Cross Section [mm ²] Power/Signal	Protection Class
M23 SpeedTec® right angle connectors (Size 1)	Power & Brake	4 / 5	20 / 10	4 / 1.5	IP65
	Commutating Encoder	- / 17	- / 10	- / 0.5	IP65
	Resolver	- / 12	- / 10	- / 0.5	IP65
	DSL	5 / 2 / 2	20 / 10	4 / 1.5	IP65
	EnDat	5 / 4 / 6	20 / 10	4 / 1.5	IP65

Servo Motor Feedback Combinations

Commutating Encoder Feedback Option

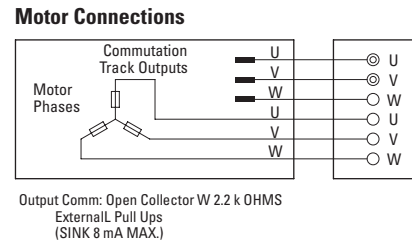
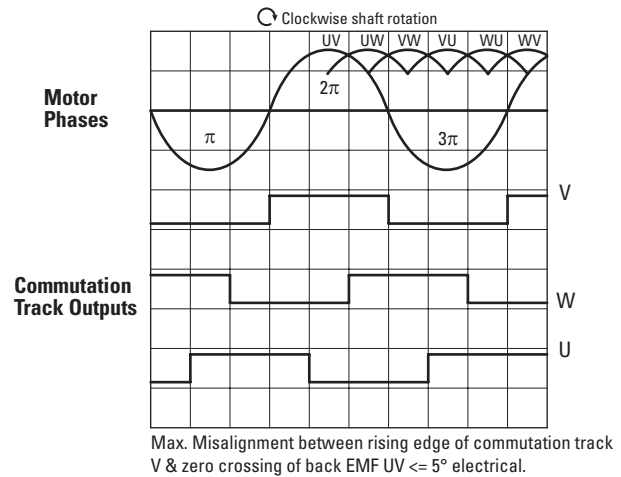
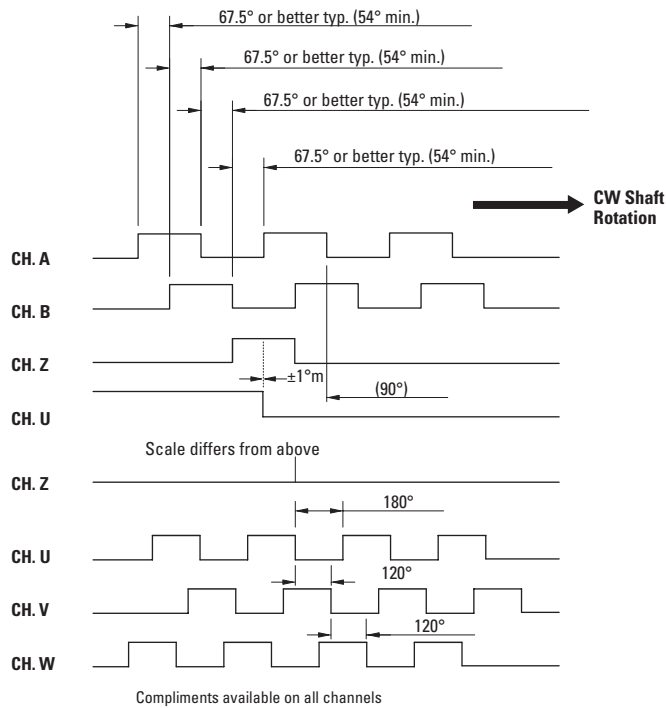

Parameter	Units	2-
Input Voltage	Vdc $\pm 10\%$	5
Output Data		26LS31 Diff. Line Driver. Sink/Source 40mA Max
Line Count		2,048
Frequency Response	KHz	200
Max. Speed	RPM	8,000
Min. Edge Separation of Incremental Channel	$^\circ$ e MIN.	45
Index to U Comm Channel		$\pm 1^\circ$ m Index Center To U Falling Edge
Index Pulse Width		Gated With B Low
Incremental Channel Accuracy		± 1 Arc Min. Max. Edge to Edge
Max. Acceleration	Rad/s ²	100,000
Operating Temperature	$^\circ$ C	0 - 120
Storage Temperature	$^\circ$ C	-40 - 120

	Type	AKM2G-3
Commutating Channel	2-	8 Pole 45°m
Moment of Inertia (kg-cm ²)	2-	0.0048

Absolute Digital Feedback Options

HIPERFACE DSL®

Type		Multi-Turn "GU"
Frame Size		AKM2G3
Number of Absolute Ascertainable Revolutions		4096
Supply Voltage Range		7 to 12
Current Consumption	mA MAX.	150
Operating Temperature	°C MIN/MAX	-40/115
Inertia	g-cm ²	1
Output Interface		SICK HIPERFACE DSL®
Type		EEM37

EnDat Inductive

Type		Multi-Turn "LD"
Frame Size		AKM2G3
Revolutions		4096
Input Voltage	Vdc	3.6 to 14
Current Consumption	mA Typical	5 V: 115 (without load)
Operating Temperature	°C MIN/MAX	-40/115
Inertia	kg-m ²	0.3x10 ⁻⁶
Output Interface		HEIDENHAIN EnDat 2.2/22
Type		EQI 1131

Resolver (Feedback)

Resolver Data	Units	AKM2G-3
		1 Speed
Input Voltage	V _{RMS}	7.0
	k Hz	10
Input Current Max.	mA	50
Transformation Ratio	N/A	0.5 ±10%
Null Voltage	mV _{RMS}	30
Max. Error (pk-pk)	MINS.	18
Phase Shift	Degrees	0
Operating Temperature	°C	-55° to 155°
Rotor Inertia Max.	kg-cm ²	0.046

Resolver Winding Configuration

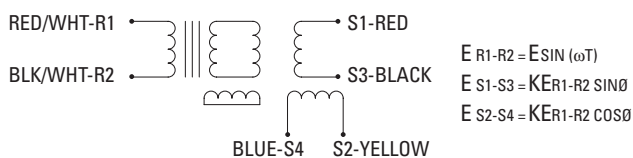

Resolver Alignment

With positive DC current into phase W and out of phase V (U floats) the resolver is aligned to electrical ±5 counts. ie. Voltage S1-S3 set to null voltage S2-S4 max in phase with reference (R1-R2).

AKM2G Servo Motor Connector Pinouts

C & G Dual Connector Pinouts – AKM2G low voltage servo motors

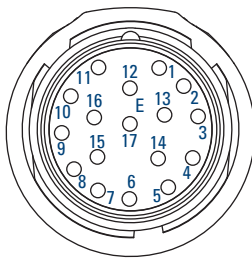
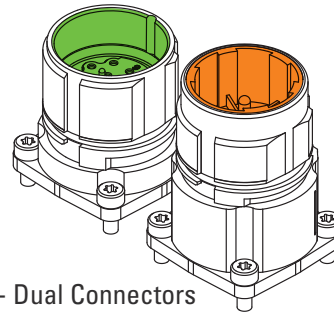
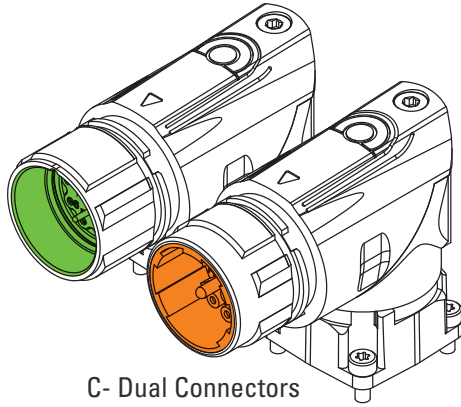

Commutating Encoder Feedback

Pin	Function
1	B
2	\bar{B}
3	A
4	\bar{A}
5	Z
6	\bar{Z}
7	GND
8	Thermal Sensor +
9	Thermal Sensor -
10	Vcc
11	N/C
12	N/C
13	N/C
14	N/C
15	U
16	V
17	W

Resolver Connector

Pin	Function
1	N/C
2	Thermal Sensor +
3	S4, COS-
4	S3, SIN-
5	R2, REF-
6	Thermal Sensor -
7	S2, COS+
8	S1, SIN+
9	R1, REF+
10	N/C
11	N/C
12	N/C

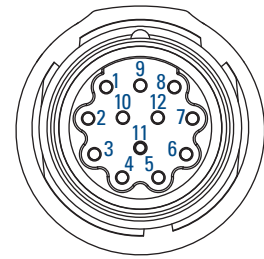

Shield is Not Connected at Motor End
On motor mounted connectors, the thermal sensor lead colors are (+) Blue, (-) Black.

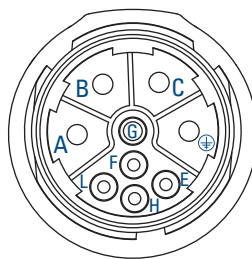

Power Connector

Pin	Function
A	U
\oplus	PE
C	W
B	V
F	Brake +
G	Brake -
E	N/C
H	N/C
L	N/C

Shield Connected to Motor
Ground Internal to Motor

D- Connector Pinouts – Hybrid combined power and feedback for DSL and EnDat for AKM2G low voltage servo motors

D- Dual Power + HIPERFACE DSL® Connector Option

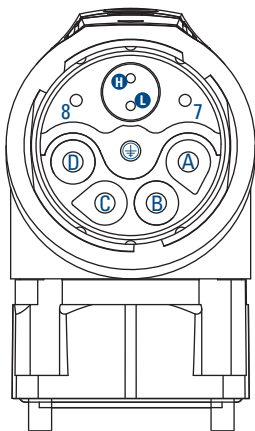

Power + DSL

Pin	Function
A	Phase U
B	Phase V
C	Phase W
D	N/C
⊕	PE
8	Brake +
7	Brake -
L	DSL -
H	DSL +

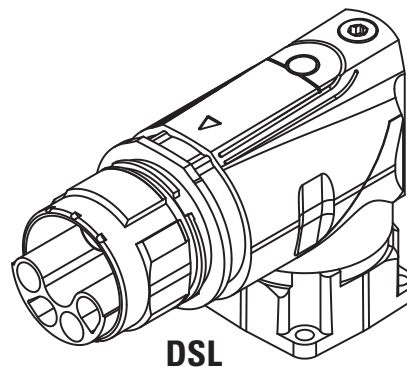

D- Dual Power + EnDat® Connector Option

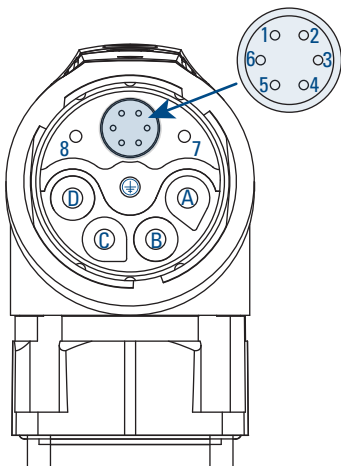

Power + EnDat

Pin	Function
A	Phase U
B	Phase V
C	Phase W
D	N/C
⊕	PE
8	Brake +
7	Brake -
1	Up
2	0 V
3	Data +
4	Data -
5	Clock +
6	Clock -

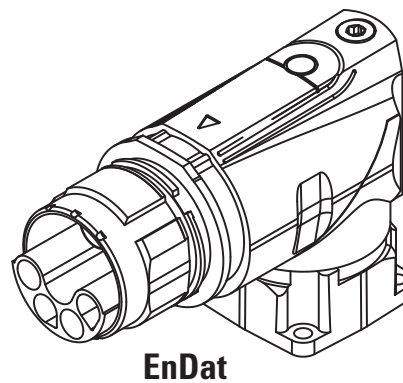

AKM2G Servo Motor Nomenclature

AKM[®]2G Low Voltage Brushless Servo Motor

AKM2G – 3 2 ML AN CN 2- 1 0

AKM2G Series

Flange Size
3 72 mm

Rotor Length
1
2
3

Winding Type
ML
PL
S Special

Mount
A IEC with accuracy N

Shaft
C Keyway
N Smooth shaft
S Special

Customization

- 0 Standard
- T Mineral filled PTFE seal (Teflon[®])
- V Viton[®] shaft seal
- x Special

Thermal Sensor

- 0 PT-1000 + PTC
- 1 PT-1000
- 2 PTC
- 3 KTY84-130 Equivalent
- S Special

Feedback Device

- For all options see page 19.
- S Special

Brake

- 2 24 V holding brake
- N Without brake
- S Special

Connections

- For all options see page 19.
- S Special

Note: Options shown in blue text are considered standard.

Kollmorgen Solutions

Automation and Motion Control

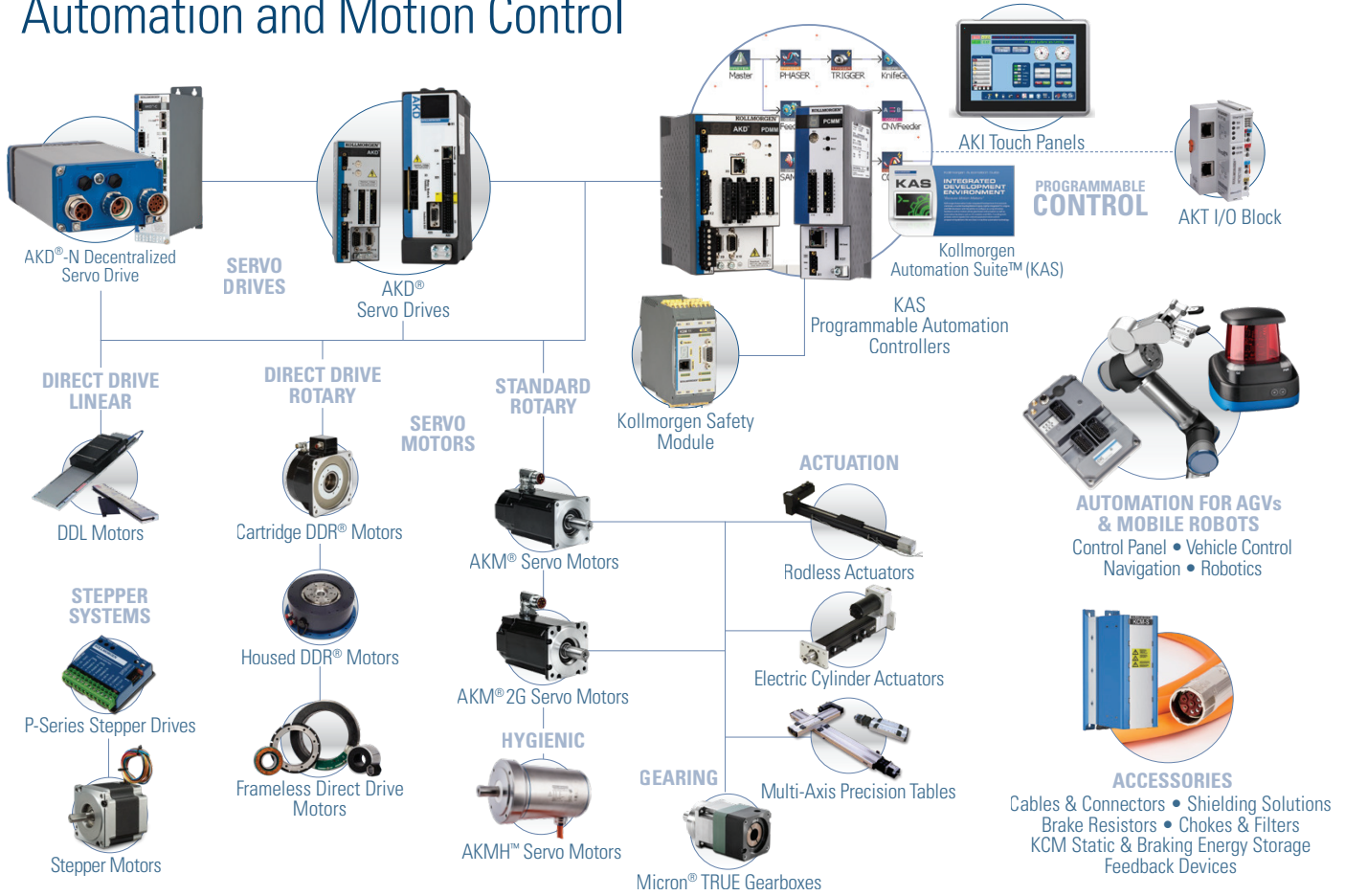

Self-Help Tools

Motioneering® Online



Size and select the right product for your application needs

Drawing Generator



Provide TBM/KBM/AKM 2D and 3D drawings in many popular formats

Performance Curve Generator



Optimize TBM/KBM/AKM windings using customer supplied environmental and drive information

Product Selector

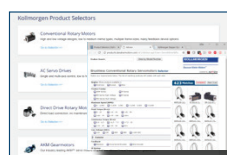

Choose right product for your application needs

Kollmorgen Developer Network



Find Answers to many key technical questions or start your own session

Stepper Optimizer

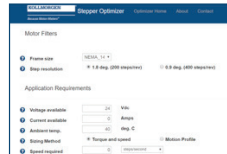

Select the most efficient stepper solution for your application

About Kollmorgen

Since its founding in 1916, Kollmorgen's innovative solutions have brought big ideas to life, kept the world safer, and improved peoples' lives. Today, its world-class knowledge of motion systems and components, industry-leading quality, and deep expertise in linking and integrating standard and custom products continually delivers breakthrough motion solutions that are unmatched in performance, reliability, and ease-of-use. This gives machine builders around the world an irrefutable marketplace advantage and provides their customers with ultimate peace-of-mind.

For assistance with your application needs in North America, contact us at: 540-633-3545, support@kollmorgen.com or visit www.kollmorgen.com for a global contact list.



KOLLMORGEN[®]

Because Motion Matters™

Kollmorgen
203A West Rock Road
Radford, VA 24141 USA
Phone: 1-540-633-3545
Fax: 1-540-639-4162

Kollmorgen Europe GmbH
Pempelfurtstraße 1
40880 Ratingen
Germany
Phone: +49 (0) 2102 9394 0
Fax: +49 (0) 2102 9394 3155

Kollmorgen Asia
Room 302, Building 5
Lihpao Plaza, 88 Shenbin Road,
Minhang District, Shanghai, China
Phone: + 86 400 668 2802

Kollmorgen Aerospace and Defense
501 West Main Street
Radford, VA 24141 USA
Phone: 1-540-731-5668
Fax: 1-540-731-5679